



skinner innovations

HST Series Heat Detector Tester

*For Rate Compensated Fire Detectors
and Thermal Switches*

HST Series Operation Manual



www.skinnerinnovations.com

email: info@skinnerinnovations.com

Rev 07-28-2015



Contents

1. Table of Contents
2. Model number configuration guide
3. Specifications
4. Safety warnings
5. Assembly
6. Operation
7. Remote Temperature Output
8. Troubleshooting
9. Service
10. Product Warranty
11. Appendix A - Technical Note: Rate Compensated Heat Detector Testing
- 12-13. Appendix B – Operation Supplement: Rate Control option / rate compensation verification
14. Appendix C- Operation Supplement: Testing Fenwal® 17343 series detectors
15. HST Output Cable
- 16-17. HST Output Extension Cable
- 18-19. HST Power Supply
- 20-21. HST Power Extension Cable

Attention:

This manual should be read by all who will be using or maintaining this product. Information herein is subject to change without notice. Testing procedures, tolerances, and pass/fail criteria are the responsibility of the end user. Information in this manual is for informational purposes only.

This product is not field repairable due to the meticulous alignment and calibration of the device.

Do not attempt to repair or modify. Doing so will impair the devices performance and void the Skinner Innovations LLC Product Warranty

This product is protected under patent numbers GB2468393 / U.S. Pat. No. 8,454,228



skinner innovations

HST Series Heat Detector Tester

For Rate Compensated Fire Detectors
and Thermal Switches

Model number configuration guide

HST- # - ### -

Sensor size:

A= 5/8"*** (Fenwal® /DAF)

B= 17/32" (Thermotech)

C= 16mm (Olsen / Tyco)

D=20mm*

E=18mm*

P=23mm* (Pastor)

Set points (degrees Fahrenheit):

ALO=140, 160, 190, 210, 225

MEL*=160, 190, 210, 225, 275

MEH*=190, 210, 225, 275, 325

ALM=225, 275, 325, 360, Cool down

AME=275, 325, 360, 450, Cool down

AMH*=325, 360, 450, 500, Cool down

AHI=450, 500, 600, 725, Cool down

BLO=135, 194 (2 temperature for Thermotech detectors)

Options:

C=rate controlled* **

*contact for availability

**special temperature rate control (see Appendix-A&B for details)

***models shown are for Fenwal® DETECT-A-FIRE® model 27127, 28021, 27120, and 28020
contact Skinner Innovations to confirm correct HST model to use with other sensors

Example model number: HST-A-ALO

HST tester- For use on 5/8" sensors, calibrated set points: 140,160,190,210, & 225°F, no options

For other temperatures, sizes, custom options, or custom temperature set points, consult
Skinner Innovations: email: info@skinnerinnovations.com



HST tester- shown with compatible poles and large carry bag (part number: HST-BAG-LRG)

Consult Skinner Innovations about where to obtain compatible poles



Specifications

HST test head:

- Anodized aluminum construction
- 1 to 5 temperature set points- factory set
- Large easy to see LED indicator light
- Heavy duty power switch
- Solid state temperature control unit
- Auto off timer feature (default setting=5 minutes *from time set-point is reached*)
- Remote temperature output- connection to directly read temperature with digital voltmeter
- CE Conformity

Battery:

- 18vdc or 24vdc Li-Ion battery pack
- Capacity: 3000mAh
- Protective circuit installed within the battery pack protects product from:
 - Over current
 - Over-charging cut-off
 - Over-discharge cut-off
 - Short circuit and wrong polarity
- Charger: Only use charger supplied with the HST battery pack
- Battery Storage: for optimum performance, store battery at 60% charge, *do not place a discharged battery into storage, as the cell voltage may further drop below acceptable voltage level and pack safety circuit will not allow re-charging*

Battery charger:

- Intelligent charger designed for Li-Ion battery pack.
- UL CE Conformity
- Worldwide input- AC power from 100V-240V -50/60Hz.
- Charging time for battery pack is about 1.5 Hrs.
- Built in circuit to cut off power automatically when battery is fully charged.
- Red LED indicates battery charging and Green LED indicates battery fully charged



Safety Warnings

Do not use the HST test tool in any area where flammable gas is present.

The HST test tool is a heat producing device; keep away from skin, body parts, and flammable materials. Do not leave unit unattended. Always wear safety glasses, appropriate gloves, and other personal protective equipment when using the tool.

The HST utilizes Li-Ion batteries; refer to the battery and charger section of this manual before charging or use. Do not make any changes to the charger, charger accessories or connectors, as this might cause electrical short, fire or over-heating during charging.

Use special caution when working with Li-Ion cells, they are sensitive to charging characteristics and should not be mishandled.

- **Never leave a charging battery unattended**
- **Do not set battery or charger on wood, carpet, or any other flammable surface**
- **Use only charger supplied, do not alter charger or battery**
- **Li-Ion cells are sensitive to charging characteristics and can be dangerous if mishandled**
- **Read and understand all instructions before use**

When using pole-mounted tools overhead, ensure that poles are locked and secure. Consult Skinner Innovations about where to obtain compatible poles.

Barricade areas around and below test areas so that persons not involved with testing will not enter the work area where overhead testing is taking place.

Always inspect poles, batteries, battery case, and HST test head for damage prior to each use. If any damage is noted during this check, remove from service immediately, and have the unit serviced.



skinner innovations

HST Series Heat Detector Tester

*For Rate Compensated Fire Detectors
and Thermal Switches*

Assembly

1. Thread the rubber straps through the loops on back side of cloth battery holder, leaving a loop in the middle of each strap.



Battery holster- showing proper installation of rubber straps



Holster with strap-loops around pole

2. Insert battery into the battery holder and secure the side release buckles.
3. Place holder over HST compatible pole with rubber straps looped around the pole



Holster with rubber strap fastened



HST Series heat detector tester- installed on an HST compatible pole

4. Snug down rubber straps and ensure that straps are secure
5. Insert test head onto pole. Ensure that buttons are secure.
6. Plug cord into battery and twist lock ring to fasten connector in place



Operation (For operation with Rate Control option, see Appendix B)

1. Ensure bypasses are in place, including disabling of any fire suppression systems.
2. Ensure that HST is correct temperature range for detectors to be tested. If using multi-temperature HST, ensure that correct temperature setting is selected.

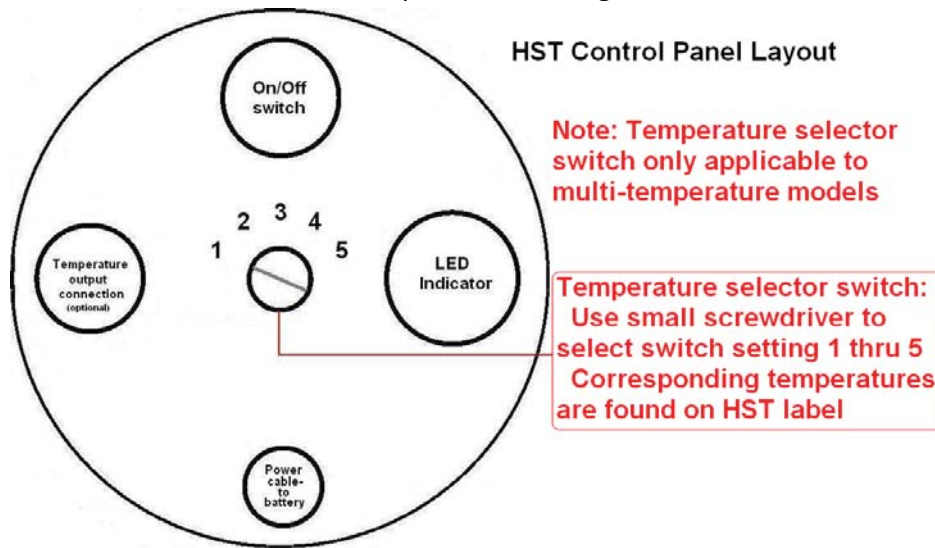

3. Turn on HST by pressing the power button. The indicator light will turn on steady until temp setting is reached.
4. Place tool over the sensor to be tested
5. Wait for sensor to trip. When the indicator light begins to cycle off and on, the tool has reached its calibrated set point. (If light does not cycle and stays off for more than 30 seconds, battery may require recharging) *After a preset timeout period, indicator light will flash at a fast rate and heating unit will turn off. To reset unit, press power button off and on again.*
6. After HST has reached its set point temperature, the temperature will hold steady for 5 minutes.
7. Next the heat will turn off for 1 minute (detector should auto-reset during this off-time) before heat is again turned on allowing user to verify the set point trip of the heat detector. (For testing with Rate Control option, see Appendix B)
8. Heat is turned off for 1 minute then on again for 3 more cycles.
9. Repeat process for each device to be tested.

Note: If the HST is not cooled down between tests, the sensor to be tested will be heated at a much faster rate. This faster rate of heating could cause the rate compensated fire detector to trip at a temperature lower than the stated set point on the sensor. See Appendix A for more information.



skinner innovations

HST Series Heat Detector Tester

For Rate Compensated Fire Detectors
and Thermal Switches

Remote Temperature Output see appendix A

1. Connect HST to digital voltmeter using special connection cable

Requires 1.5 meter cable part number HST-A5-CBL (sold separately). For longer distance use with 8.3 meter extension cable part number HST-EXT-CBL.

2. Read temperature directly from voltmeter.

Example: 0.325vdc = 325 degrees F

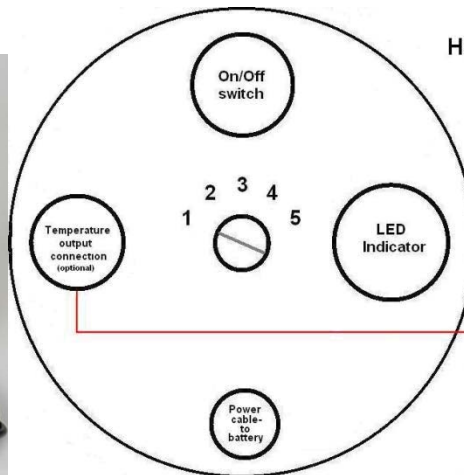

HST Control Panel Layout

Remote Temperature Output:
Connect to digital voltmeter
to read tester temperature
(0 to 1 vdc signal)

**Example: 0.140 = 140
degrees F**

Notes on Remote Temp Output (also see appendix A):

1. If sensor trips lower than the manufacturer's set point:
 - a.) Remember that some detectors are Rate Compensated. The actual trip point will vary depending ambient temperature and the rate of temperature rise.
2. If sensor does not trip:
 - a.) Check sensor shell for damage. Small dings, dents, and overheating can shift the set point.
 - b.) Let sensor cool down, then place fully heated tester onto sensor
 - c.) If using multi-temperature tester, try turning up to next temp setting.



Troubleshooting

Problem	Possible cause	Remedy
Indicator light does not turn on	If indicator light stays off for over 60 seconds, power may be off or battery may require recharging	<ol style="list-style-type: none">1. Push power button2. Recharge battery
Indicator light on, unit heating, but sensor is not tripping	<ol style="list-style-type: none">1. Sensor set point is higher than the set point of the HST2. Detector is damaged3. HST tester model incorrect for detector	<p>Sensor/detector may be damaged Visually check sensor for damage, including signs of overheating.</p> <ol style="list-style-type: none">1. Use tool with proper set point2. Place fully heated tool onto ambient temperature sensor. If sensor trips, its set point may have shifted (a common result of overheating or other damage)3. Confirm HST model is matches detector4. Try using the tester on a known working sensor
Indicator light flashing at 2-blink rate	Heater fault	<ol style="list-style-type: none">1. Charge battery2. Return for service
Indicator light flashing at 3-blink rate	Internal sensor has detected a failure	Return for service
Indicator light flashing at 4-blink rate	Over temperature alarm the tester is above the selected set point temp (This will occur when changing from a high temp setting to a lower temp setting)	<ol style="list-style-type: none">1. Allow unit to cool down to set point temperature2. Reset by pressing power button off and then restarting
Indicator light flashing on and off quickly	Internal safety timer has timed out	Reset by pressing power button off and then restarting



skinner innovations

HST Series Heat Detector Tester

*For Rate Compensated Fire Detectors
and Thermal Switches*

Service

For technical assistance or repair contact Skinner Innovations

Email: service@skinnerinnovations.com

Website: www.skinnerinnovations.com

Mailing address:

Skinner Innovations LLC
4 North Archmore Street
Saratoga Springs, Utah 84045

Phone: (801) 766- 4782

Along with a detailed description of the problem, please include:

1. The manufacturer, model number, and set point of the heat sensors you are testing.
2. The model and serial number of the HST

Periodic Service and maintenance:

1. Inspect the tool as described in this manual before each use.
2. Return tool to Skinner Innovations LLC for repair or calibration.

Call for return authorization prior to sending in any unit for service or repair.

3. Do not attempt to disassemble the tool. There are no user serviceable parts. Special care is required for disassembly.



skinner innovations

HST Series Heat Detector Tester

*For Rate Compensated Fire Detectors
and Thermal Switches*

Product Warranty

To the original purchaser, for one year from date of purchase, Skinner Innovations LLC will warranty repair or replace any damaged components that are determined to be the result of manufacturer defect. Any unit that has been opened up, disassembled, or otherwise worked on by anyone other than Skinner Innovations LLC, will not be covered under this warranty. Normal wear and tear is not covered. Scratches and other cosmetic issues are not covered. Batteries, cloth battery holder, and rubber straps are not covered other than for manufacturer defect.

This warranty statement is not intended to limit or take away any persons legal rights.

Contact Skinner Innovations LLC customer service before returning any unit for warranty repair.



Appendix-A Technical Note: Rate Compensated Heat Detector Testing

Interpretation of test results

The purpose of this note is to explain detector set point, rate compensation, and how this should affect the interpretation of test results observed on remote temperature readout of the HST heat detector tester. The HST remote temperature output is taken directly from the heating unit. Detector trip points will often be observed to be lower than the manufacturer rated set point. This is due to the unique way rate compensation works to self-adjust the set point based on how quickly the temperature is rising from the starting temperature.

Set Point versus trip point- "virtual set point"

The unique feature of Rate Compensated heat detectors: "virtual" set point.

The detector has two parts which expand or contract with temperature changes.

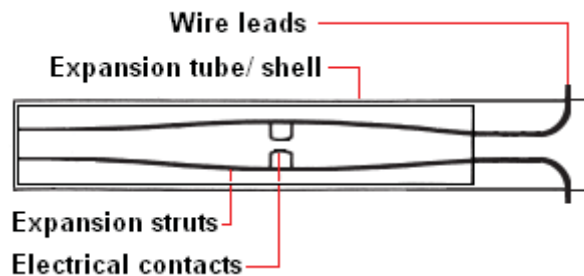

First is the outer expansion tube or shell.

Second is a pair of expansion "struts" or metal strips. This interior part also contains the electrical contacts.

These two parts work together to cause the detector to behave in 2 different ways:

1st- A slow rate of temp rise- Heat is allowed to penetrate into the struts, both parts expand together and detector trips close to the rated set point.

2nd- A high rate of temp rise- The shell rapidly expands before heat can penetrate to struts and the detector trips at a temperature that would appear to be lower than the rated set point.

Manufacturer Calibration (UL testing) vs. Compliance Testing

New heat detectors are calibrated (tested to UL521 standard) to a rated +/- set point.

This is done by raising the temperature in very slow, controlled manner (varying rates depending on the temperature of the detector).

For example: the temperature could be raised at 50 degrees per minute until 150 degrees is reached. Then continue at 1 degree per minute until the detector trips at 225°. Ambient temperature also needs to be accounted for by heating to a pre-determined starting temperature for a set period of time. The detector should then trip within the +/- range of manufacturers set point specification. *This type of testing is not required for normal detector compliance testing.*

Compliance testing is done after installation of the detector in the intended area of use and is required by the authority having jurisdiction. There is no requirement to test for a specific temperature. *However, the test should not damage the detector.*

The HST can be custom programmed to raise temperature at a slower rate to trip detector closer to the rated set point. (see Rate Control option Appendix B) However, the HST's intended application is to compliance test detectors in a non destructive manner, identify shifts in set point, and help ensure that the detector continues to operate as it was originally calibrated by the manufacturer. Per the UL standard, there is no way to field re-calibrate a heat/fire detector.



Appendix-B Operation supplement:

Testing rate compensated heat detectors - HST Rate Control option/ Rate Compensation Verification

Sequence of Operation

Turn on HST by pressing the power button. Place tester firmly over detector. Then follow test stages 1-4 below.

Test Stage	HST LED condition	Power on/ sequence of operation	Observed condition	Interpretation of test results*	Example results 140°F (+7/-8°) Fenwal DAF detector
Stage 1 (used on rate control models)	LED steady on until 60-80% temp When LED goes off, then flashes 1 time every 15 seconds, 180 second hold timer is active	Temperature rises to 60-80% of set point Then begin 180 second stage 1 hold timer	Detector should trip for 1st time while temperature is rising. If using remote temp display, note the trip temperature.	Failure to trip may indicate detector set point has shifted high	1st detector trip at 124°F Hold temperature 128°F
	1st stage hold time: LED turns off then flashes 1 time every 15 seconds	Temperature holds at 60-80% of set point for 180 seconds	Detector should auto-reset within 1-2 minutes. Observe that detector has reset.	Failure to auto-reset may indicate detector set point has shifted high	Auto-reset approx 30 seconds after 1st stage timer begins
Stage 2 (not used on all models)	LED steady on When LED goes off, then flashes 2 times every 15 seconds, 180 second hold timer is active	Temperature rises to 85-95% of set point Begin 180 second stage 2 hold timer	Detector should trip for 2nd time while temperature is rising. If using remote temp display, note the trip temperature.	Failure to trip may indicate detector set point has shifted high	2nd detector trip at 130°F Hold temperature 136°F
	During 2nd stage hold, LED turns off then flashes 2 times every 15 seconds	Temperature holds at 85-95% of set point for 180 seconds	Detector should auto-reset within 1-2 minutes. Observe that detector has reset.	Failure to auto-reset may indicate detector set point has shifted high	Auto-reset approx 30 seconds after 2nd stage timer begins
Stage 3	LED steady on until temperature is a few degrees below the rated set point, then LED begins slow flash	Temperature rises to detectors rated set point	Detector should trip for 3rd time while temperature is rising. If using remote temp display, note the trip temperature.	Failure to trip may indicate detector set point has shifted high. Auto reset after tester has stabilized may indicate that detector has shifted low	3rd detector trip at 140°F
Stage 4	LED steady on until temperature is a few degrees below the rated set point, then LED begins slow flash	Temperature holds for 5 minutes then heat turns off for approx 60-90 seconds	Detector should auto-reset during off-time. Then, temperature begins to climb to set point again.	Detector should trip at the actual set point at this time	4th Detector trip at 141°F 5th Detector trip at 139°F 6th Detector trip at 142°F
	Stage 4 repeats 3 more times with 5 second hold time between cycles, then temperature holds steady at set point Use the average of the last four trips to determine the actual trip point*				



Appendix-B Operation supplement:

Testing rate compensated heat detectors - HST Rate Control option/ Rate Compensation Verification (cont.)

* Notes on testing rate compensated heat detectors using HST Series Heat Detector tester with rate control/rate compensation verification:

- The LED indicator light flashes to indicate test progress. If the HST is producing quick flashes, this may indicate a fault. Count the number of flashes and consult this manual or Skinner Innovations.
- Results will vary somewhat depending on ambient conditions.
- Do not expect trip points to be exactly as in the example or exactly at the manufacturers rated set point.
- Completely cool the tester before starting on next rate compensation detector test.
- After noting trip points for all detectors, it is recommended to use manufacturers +/- tolerances and good judgment to determine

Pass/Fail criteria for your particular environment. Detectors should be within similar +/- tolerances. A device which falls outside of this parameter may require replacement or further evaluation. *Results will vary somewhat depending on ambient temperature, battery charge, etc. The HST can accurately determine if detector set point has shifted low or high. However these limitations should be considered when interpreting test results.*

Detector calibration requires specialized laboratory-type equipment and is performed on new detectors at the manufacturers factory. The HST will help to detect major shifts in set point but is not intended to be used to calibrate heat detectors. To meet listing requirements, detector manufactures do not usually provide a way to field adjust heat detector set point.

The material presented in this document is for informational purposes only. Follow the manufacturer's specific testing instructions. Detectors may require additional tests, especially if open flame or other uncontrolled source of heat has been used in the past for testing purposes. See Fenwal® Operation, Maintenance and Installation manual for complete testing instructions.



Appendix-C Operation Supplement: Model HST-A-17343-124-1, HST-A-17343-124-2, HST-A-17343-124-3

Testing Fenwal® Fire/Overheat Detector part number 17343-124 using the HST Series heat detector tester.

The following HST models are available for testing Fenwal® 17343-124 detectors:

- Model HST-A-17343-124-1 for 140 degree F detector
- Model HST-A-17343-124-2 for 325 and 425 degree F detectors
- Model HST-A-17343-124-3 for 600 and 725 degree F detectors

Operation:

1. Select the desired temperature setting on the HST tester. The HST temperature setting refers to the detectors rated trip point, the actual temperature that the HST produce will be slightly higher to account for the manufacturers +/- specification. For additional operation instructions see the "Operation" section of the HST Series Operations Manual
2. Turn on power to the HST and place tester over the detector. The indicator light will turn on while temperature is rising. Indicator light will blink slowly when the HST is close to the detector set point. This may take several minutes. As the temperature nears the set point the rate of rise will be slower, if detector has not already tripped, continue to wait until temperature stops climbing.
3. When detector trips, note the temperature readout on the voltmeter
For more information refer to HST Operations Manual section on "Remote Temperature Output"
If temperature has completely stabilized and the detector still has not tripped, turn the HST to the next higher temperature setting until it does trip, then return the HST set point to the correct temperature setting and proceed to step 4.
4. Cycle power to HST off for 5 seconds, then turn power back on.
The HST will begin to cool briefly when power is cycled, during this time the detector should cool enough to reset.
After HST re-boots temperature will start to climb, continue to watch temperature readout and note when detector trips.
5. Repeat step 4, two additional times until you have recorded a total of 4 separate trips
6. Take the average of only the last three trips points only and record this as the actual trip point
7. Three minutes after the HST has reached the maximum temperature, the heating unit will turn off and the indicator light will blink rapidly. Continue to watch the temperature readout and remove tester when the temperature drops to within 100 degrees of the ambient temperature.
8. Repeat steps 1 thru 7 for remaining detectors

Interpretation of test results:

After noting trip points for all the detectors, it is recommended to use manufacturers +/- tolerances and good judgment to determine Pass/Fail criteria for your particular environment. Detectors should be within similar +/- tolerances. A device which falls outside of this parameter may require replacement or further evaluation. *Results will vary somewhat depending on ambient temperature, battery charge, etc.*

Detector calibration requires specialized laboratory-type equipment and is performed on new detectors at the manufacturers factory. The HST will help to detect major shifts in set point but is not intended to be used to calibrate heat detectors. To meet listing requirements, detector manufactures do not usually provide a way to field adjust heat detector set point.

The material presented in this document is for informational purposes only. Follow the manufacturer's specific testing instructions. Detectors may require additional tests, especially if open flame or other uncontrolled source of heat has been used in the past for testing purposes. See Fenwal® Operation, Maintenance and Installation manual for complete testing instructions.

<u>Example test 1</u>	Trip temp	Manufacturer	Detector Set Point	Manufacturers tolerance
Trip 1	724°	Fenwal®	725	+/-25
Trip 2	729°			
Trip 3	719°			
Trip 4	718°			
Result	722°			
<u>Example test 2</u>				
Trip 1	755°	No initial trip using the 725 setting, changed temp setting to next higher setting, until trip, then return to 725		
Trip 2	729°			
Trip 3	719°			
Trip 4	718°			
Result	722°	Average of Trip 2, Trip 3, and Trip 4		



Remote Temperature Output Connection Cable

Specifications

Part Number: HSTA5CBL

FEATURES:

- This double banana plug cable is designed to be used with all standard .166" (4mm) diameter banana jacks. It can be used with most digital multimeters that have the common and volt-ohm jacks at the standard spacing. These jacks are usually spaced at .75" (19mm) Apart
- Use with 23' (7m) HST extension cable p/n HST-EXT-CBL for combined reach of about 27.5' (8.3m)

MATERIALS:

- The double banana plug is insert molded with black polypropylene
- The cable is RG58C/U - 0.195" diameter – 50 ohms impedance
- The HST double pin cable connector is UL recognized black Nylon

ELECTRICAL / MECHANICAL:

- Durability – minimum 300 cycles without mechanical or electrical failure
- Voltage – Maximum 24vdc @ 2 amps

ENVIRONMENTAL:

- Temperature- -55°C to +55°C (-67°F to +131°F)
- Corrosion 300 Hr salt spray contacts

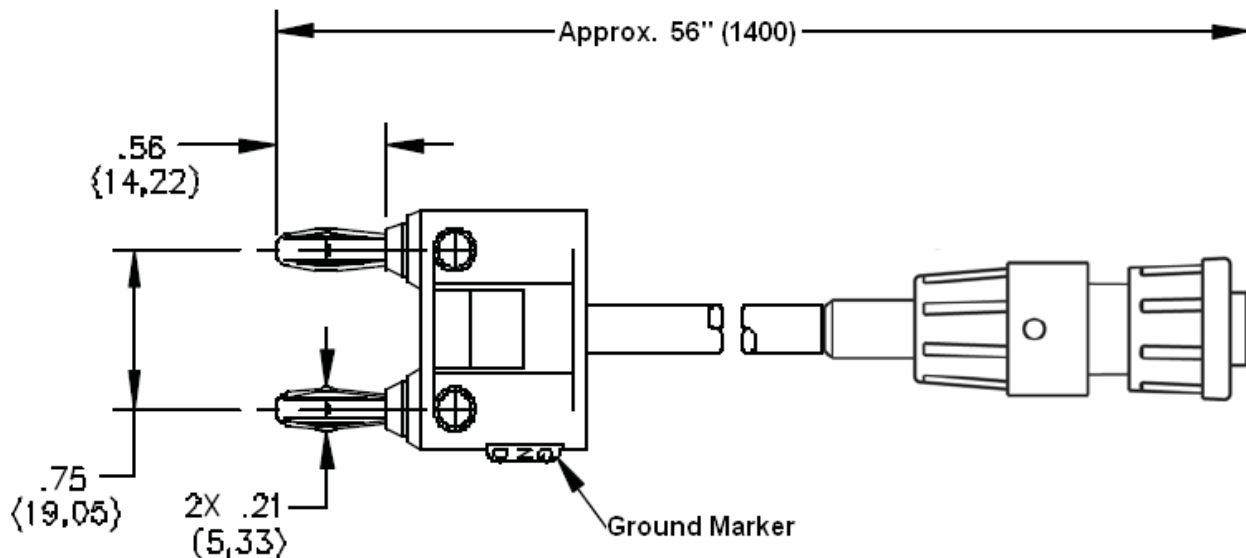

HST Output Extension Cable

Specifications

Part Number: HSTEXTCBL

FEATURES:

- The heavy duty coiled extension cable is designed to be connected with standard HST remote temperature output and the standard connection cable HST-A5-CBL. The combined length of these cables is approx. 27.5' (8.3m)
- Allows for monitoring of temperature at heights and greater troubleshooting capabilities
- Retracted Length: approx. 64" (1.6m)
- Working length: approx. 23' (7m)
- Rubber strap at male connector end fastens to inspection pole to prevent cable from pulling on connectors and prevents cable from falling should it become disconnected while in use. **Do not use if rubber strap is not in place and properly fastened.**

MATERIALS:

- The cable is 2 conductor, 0.18" diameter – coil O.D. is 5/8"
- The HST double pin cable connectors on each end are UL recognized black Nylon

ELECTRICAL / MECHANICAL:

- Durability – minimum 300 cycles without mechanical or electrical failure
- Voltage – Maximum 24vdc @ 1.0 amps
- Weight: 8.5oz

ENVIRONMENTAL:

- Temperature- -55°C to +55°C (-67°F to +131°F)

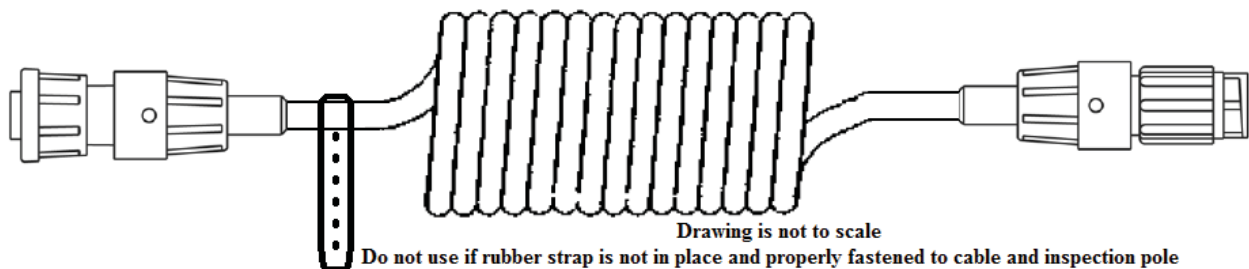



skinner innovations

HST Series Heat Detector Tester

*For Rate Compensated Fire Detectors
and Thermal Switches*

HST Output Extension Cable

Important directions on safe usage

Part Number: HSTEXTCBL

When using with extension poles, the cable must be fastened to the inspection pole using the rubber strap provided. The purpose of this is to provide strain relief on the connectors and to prevent the cable from falling on the user should the connection to the HST become disconnected. Make sure that cable does not touch hot surface, moving equipment, or any other dangerous surface.

See following picture for clarification on proper attachment.



Picture 1: Fasten the axial cable lead to the pole using the rubber strap provided. Note that the actual cable has longer axial lead than pictured to provide for swivel movement of test head

DO NOT USE CABLE WITHOUT SECURING CABLE TO POLE USING RUBBER STRAP

HST Power Supply Specifications

Part Numbers: HSTPWR148, HSTPWR185, HSTPWR259

FEATURES:

- Universal AC input
- 3 pole AC inlet connector IEC320-C14
- Output:
 - 15VDC (14 volt HST models)
 - 20VDC (18 volt HST models)
 - 24VDC (24 volt HST models)
- Allows for providing power to HST heat detector tester at distances of up to 20 feet away when used with 20' extension cable p/n HSTEXT148, HSTEXT185, or HSTEXT259
- Fanless design, cooling by free air convection

MATERIALS:

- Housing- hard ABS plastic
- Output cable connector- 250 volt, IP40 connector, bayonet locking, PA and PBT plastic

ELECTRICAL / MECHANICAL:

- Durability – minimum 300 cycles without mechanical or electrical failure
- Voltage- 90-264VAC
- Frequency range- 47-63Hz
- AC current- 3A/115VAC 1.5A/230VAC
- Model, Voltage, Connector configurations:
 - Model HSTPWR148, use with 14 volt HST, 15vdc output, 2pin connector
 - Model HSTPWR185, use with 18 volt HST, 20vdc output, 4pin connector
 - Model HSTPWR259, use with 24 volt HST, 24vdc output, 3pin connector
- Weight: 1.5kg

ENVIRONMENTAL:

- Temperature- -30°C to +60°C
- Humidity- 20%-90% RH non-condensing

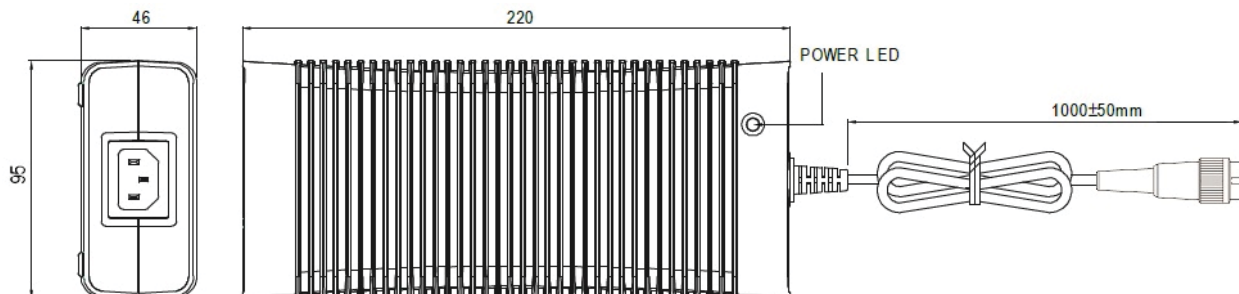



skinner innovations

HST Series Heat Detector Tester

*For Rate Compensated Fire Detectors
and Thermal Switches*

HST Power Supply

Important directions on safe usage

Part Numbers: HSTPWR148, HSTPWR185, HSTPWR259

When using power supply with extension cable part numbers HSTEXT148, HSTEXT185, or HSTEXT259, the extension cable must be fastened to the inspection pole using the rubber strap provided. The purpose of this is to provide strain relief on the connectors and to prevent the cable from falling on the user should the connection to the HST become disconnected. Make sure that cable does not touch hot surface, moving equipment, or any other dangerous surface.

See following picture for clarification.



Picture 1: Fasten the axial cable lead to the pole using the rubber strap provided.

DO NOT USE CABLE WITHOUT SECURING CABLE TO POLE USING RUBBER STRAP



HST Power Extension Cable

Specifications

Part Numbers: HSTEXT148, HSTEXT185, HSTEXT259

FEATURES:

- The heavy duty coiled power extension cable is designed to provide extended power cable length when using an HST Stand Alone Power supply.
- Allows for providing power to HST heat detector tester at distances of up to 20 feet away from the stand alone power supply.
- Retracted Length: approx. 48" (1.2m)
- Working length: approx. 20' (6m)
- Rubber strap at male connector end fastens to inspection pole to prevent the weight of the cable from pulling on connectors and prevents cable from falling should it become disconnected while in use. **Do not use if rubber strap is not in place and properly fastened.**

MATERIALS:

- The cable is 2 conductor, 300volt, 0.25" diameter – coil O.D. is 0.85"
- The cable connectors 250 volt, IP40 connector, bayonet locking, PA and PBT plastic

ELECTRICAL / MECHANICAL:

- Durability – minimum 300 cycles without mechanical or electrical failure
- Voltage – Maximum 24vdc @ 10.0 amps
- Voltage/Connector configurations:
 - Model HSTEXT148, 14 volt, 2pin connector
 - Model HSTEXT185, 18 volt, 4 pin connector
 - Model HSTEXT259, 24 volt, 3 pin connector
- Weight: 0.95 lbs

ENVIRONMENTAL:

- Temperature- -40°C to +85°C (-40°F to +185°F)

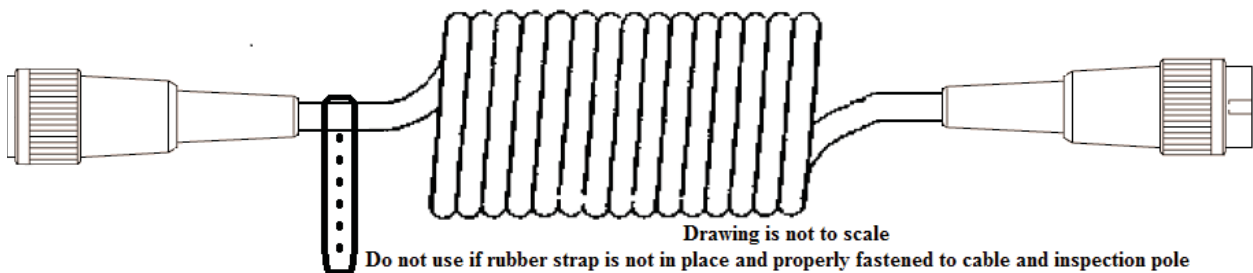



skinner innovations

HST Series Heat Detector Tester

*For Rate Compensated Fire Detectors
and Thermal Switches*

HST Power Extension Cable

Important directions on safe usage

Part Numbers: HSTEXT148, HSTEXT185, HSTEXT259

When using with extension poles, the cable must be fastened to the inspection pole using the rubber strap provided. The purpose of this is to provide strain relief on the connectors and to prevent the cable from falling on the user should the connection to the HST become disconnected. Make sure that cable does not touch hot surface, moving equipment, or any other dangerous surface.

See following picture for clarification on proper attachment.



Picture 1: Fasten the axial cable lead to the pole using the rubber strap provided.

DO NOT USE CABLE WITHOUT SECURING CABLE TO POLE USING RUBBER STRAP